



# Cheval Series

Benches & Tables



---

## Cheval Series Specifications

---

**Collection Details** Bench Seating & Tables | Modulars  
20" | 40" | 60" | 45° Corner Unit | 90° Corner Unit

---

**Surfaces** Ash  
Refer to HBF Standard Ash finishes for color selection. Finish selection must be noted on order.

---

**Leg Finish** Polished Aluminum

---

**Cushion** Single 16" | Double 26" | Full (Triple) 56"

---

**Cushion Placement** Left Center | Center | Right Center

---

Cushion Positions	
<b>NC</b>	No Cushion
<b>SC</b>	Single Cushion
<b>DC</b>	Double Cushion
<b>TC</b>	Triple Cushion
<b>NA</b>	Not Applicable





# Cheval Series

## Benches & Tables

	List Prices	Sq.Ft.	Yards	Dimensions
<b>Cheval HHL115011</b>				
	1075			OH 17½ AH OW 20 WBA OD 17 DED SH 17½ DEW SD 15 R
				Shipping Weight Cube
				level® Certified SCS Indoor Advantage™ Certified
One Seat Bench   No Cushion   Polished Aluminum Legs				

	List Prices	Sq.Ft.	Yards	Dimensions
<b>Cheval HHL115011</b>				
	COM 1400 COL 1575 Grade AA 1453 Grade A 1467 Grade B 1480 Grade C 1493 Grade D 1506 Grade E 1517 Grade F 1531 Grade G 1542 Grade H 1559	Grade J 1570 Grade K 1582 Grade L 1593 Grade M 1604 Grade N 1622 Grade P 1638 Grade Q 1651 Leather I 1640 Leather II 1760 Leather III 1860 Leather IV 1920	Leather V 1960 Edel 1 1910 Edel 2 1970 Edel 3 2060 Edel 4 2080 Edel 5 2190 Edel 6 2240 Edel 7 2380 Edel 12 3260	18 1 OH 18¼ AH OW 20 WBA OD 17 DED SH 18¼ DEW SD 15 R
				Shipping Weight Cube
				level® Certified SCS Indoor Advantage™ Certified
One Seat Bench   Single Seat Center Cushion   Polished Aluminum Legs				

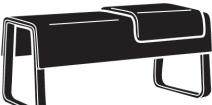
	List Prices	Sq.Ft.	Yards	Dimensions
<b>Cheval HHL115012</b>				
	1200			OH 17½ AH OW 40 WBA OD 17 DED SH 17½ DEW SD 15 R
				Shipping Weight Cube
				level® Certified SCS Indoor Advantage™ Certified
Two Seat Bench   No Cushion   Polished Aluminum Legs				

	List Prices	Sq.Ft.	Yards	Dimensions
<b>Cheval HHL115012</b>				
	COM 1525 COL 1700 Grade AA 1578 Grade A 1592 Grade B 1605 Grade C 1618 Grade D 1631 Grade E 1642 Grade F 1656 Grade G 1667 Grade H 1684	Grade J 1695 Grade K 1707 Grade L 1718 Grade M 1729 Grade N 1747 Grade P 1763 Grade Q 1776 Leather I 1765 Leather II 1885 Leather III 1985 Leather IV 2045	Leather V 2085 Edel 1 2035 Edel 2 2095 Edel 3 2185 Edel 4 2205 Edel 5 2315 Edel 6 2365 Edel 7 2505 Edel 12 3385	18 1 OH 18¼ AH OW 40 WBA OD 18 DED SH 18¼ DEW SD 16 R
<i>One Single Right Seat Cushion</i>				Shipping Weight Cube
				
<i>One Single Left Seat Cushion</i>				
				level® Certified SCS Indoor Advantage™ Certified
Two Seat Bench   One Single Cushion   Polished Aluminum Legs				



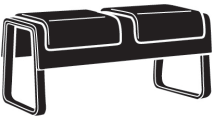

# Cheval Series

## Benches & Tables

	List Prices				Sq.Ft.	Yards	Dimensions			
<b>Cheval HHL115012</b>										
	COM	1850	Grade J	2190	Leather V	2971	36	2	OH 18¼	AH
	COL	2025	Grade K	2214	Edel 1	2871			OW 40	WBA
	Grade AA	1957	Grade L	2237	Edel 2	2991			OD 18	DED
	Grade A	1983	Grade M	2259	Edel 3	3171			SH 18¼	DEW
	Grade B	2010	Grade N	2294	Edel 4	3211			SD 16	R
	Grade C	2037	Grade P	2326	Edel 5	3431				
	Grade D	2061	Grade Q	2352	Edel 6	3531				
	Grade E	2083	Leather I	2330	Edel 7	3811				Shipping Weight
	Grade F	2112	Leather II	2571	Edel 12	5571				Cube
	Grade G	2134	Leather III	2771						
	Grade H	2168	Leather IV	2891						
One Seat Bench   Two Single Seat Cushions   Polished Aluminum Legs										
level <sup>®</sup> Certified SCS Indoor Advantage™ Certified										

<b>Cheval HHL115012</b>										
	COM	1625	Grade J	1965	Leather V	2746	36	2	OH 18¼	AH
	COL	1800	Grade K	1989	Edel 1	2646			OW 40	WBA
	Grade AA	1732	Grade L	2012	Edel 2	2766			OD 18	DED
	Grade A	1758	Grade M	2034	Edel 3	2946			SH 18¼	DEW
	Grade B	1785	Grade N	2069	Edel 4	2986			SD 16	R
	Grade C	1812	Grade P	2101	Edel 5	3206				
	Grade D	1836	Grade Q	2127	Edel 6	3306				
	Grade E	1858	Leather I	2105	Edel 7	3586				Shipping Weight
	Grade F	1887	Leather II	2346	Edel 12	5346				Cube
	Grade G	1909	Leather III	2546						
	Grade H	1943	Leather IV	2666						
Two Seat Bench   One Double Seat Cushion   Polished Aluminum Legs										
level <sup>®</sup> Certified SCS Indoor Advantage™ Certified										



<b>Cheval HHL115013</b>										
	1325								OH 17½	AH
									OW 60	WBA
									OD 17	DED
									SH 17½	DEW
									SD 15	R
Three Seat Bench   No Seat Cushion   Polished Aluminum Legs										
level <sup>®</sup> Certified SCS Indoor Advantage™ Certified										

<b>Cheval HHL115013</b>										
	COM	1650	Grade J	1820	Leather V	2210	18	1	OH 18¼	AH
	COL	1825	Grade K	1832	Edel 1	2160			OW 60	WBA
	Grade AA	1703	Grade L	1843	Edel 2	2220			OD 18	DED
	Grade A	1717	Grade M	1854	Edel 3	2310			SH 18¼	DEW
	Grade B	1730	Grade N	1872	Edel 4	2330			SD 16	R
	Grade C	1743	Grade P	1888	Edel 5	2440				
	Grade D	1756	Grade Q	1901	Edel 6	2490				
	Grade E	1767	Leather I	1890	Edel 7	2630				Shipping Weight
	Grade F	1781	Leather II	2010	Edel 12	3510				Cube
	Grade G	1792	Leather III	2110						
	Grade H	1809	Leather IV	2170						
One Single Right Center Seat Cushion										
	COM	1650	Grade J	1820	Leather V	2210	18	1	OH 18¼	AH
	COL	1825	Grade K	1832	Edel 1	2160			OW 60	WBA
	Grade AA	1703	Grade L	1843	Edel 2	2220			OD 18	DED
	Grade A	1717	Grade M	1854	Edel 3	2310			SH 18¼	DEW
	Grade B	1730	Grade N	1872	Edel 4	2330			SD 16	R
	Grade C	1743	Grade P	1888	Edel 5	2440				
	Grade D	1756	Grade Q	1901	Edel 6	2490				
	Grade E	1767	Leather I	1890	Edel 7	2630				Shipping Weight
	Grade F	1781	Leather II	2010	Edel 12	3510				Cube
	Grade G	1792	Leather III	2110						
	Grade H	1809	Leather IV	2170						
One Single Center Seat Cushion										
	COM	1650	Grade J	1820	Leather V	2210	18	1	OH 18¼	AH
	COL	1825	Grade K	1832	Edel 1	2160			OW 60	WBA
	Grade AA	1703	Grade L	1843	Edel 2	2220			OD 18	DED
	Grade A	1717	Grade M	1854	Edel 3	2310			SH 18¼	DEW
	Grade B	1730	Grade N	1872	Edel 4	2330			SD 16	R
	Grade C	1743	Grade P	1888	Edel 5	2440				
	Grade D	1756	Grade Q	1901	Edel 6	2490				
	Grade E	1767	Leather I	1890	Edel 7	2630				Shipping Weight
	Grade F	1781	Leather II	2010	Edel 12	3510				Cube
	Grade G	1792	Leather III	2110						
	Grade H	1809	Leather IV	2170						
One Single Left Center Seat Cushion										
Three Seat Bench   One Single Seat Cushion   Polished Aluminum Legs										
level <sup>®</sup> Certified SCS Indoor Advantage™ Certified										





# Cheval Series

## Benches & Tables

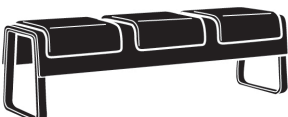
	List Prices				Sq.Ft.	Yards	Dimensions				
<b>Cheval HHL115013</b>											
 <p>Two Single Right Center and Center Seat Cushions</p>  <p>Two Single Left Center and Center Seat Cushions</p>  <p>Two Single Left Center and Right Center (Split) Seat Cushions</p>	COM	1975	Grade J	2315	Leather V	3096	36	2	OH	18¼	AH
	COL	2150	Grade K	2339	Edel 1	2996			OW	60	WBA
	Grade AA	2082	Grade L	2362	Edel 2	3116			OD	18	DED
	Grade A	2108	Grade M	2384	Edel 3	3296			SH	18¼	DEW
	Grade B	2135	Grade N	2419	Edel 4	3336			SD	16	R
	Grade C	2162	Grade P	2451	Edel 5	3556			Shipping Weight Cube		
	Grade D	2186	Grade Q	2477	Edel 6	3656					
	Grade E	2208	Leather I	2455	Edel 7	3936					
	Grade F	2237	Leather II	2696	Edel 12	5696					
	Grade G	2259	Leather III	2896							
	Grade H	2293	Leather IV	3016							
	Three Seat Bench   Two Single Seat Cushions   Polished Aluminum Legs								level® Certified SCS Indoor Advantage™ Certified		



<b>Cheval HHL115013</b>											
 <p>Three Single Seat Cushions</p>	COM	2300	Grade J	2810	Leather V	3981	54	3	OH	18¼	AH
	COL	2475	Grade K	2847	Edel 1	3831			OW	40	WBA
	Grade AA	2460	Grade L	2880	Edel 2	4011			OD	18	DED
	Grade A	2500	Grade M	2913	Edel 3	4281			SH	18¼	DEW
	Grade B	2540	Grade N	2967	Edel 4	4341			SD	16	R
	Grade C	2580	Grade P	3013	Edel 5	4671			Shipping Weight Cube		
	Grade D	2617	Grade Q	3053	Edel 6	4821					
	Grade E	2650	Leather I	3020	Edel 7	5241					
	Grade F	2693	Leather II	3381	Edel 12	7881					
	Grade G	2727	Leather III	3681							
	Grade H	2777	Leather IV	3861							
	Three Seat Bench   Three Single Seat Cushions   Polished Aluminum Legs								level® Certified SCS Indoor Advantage™ Certified		

<b>Cheval HHL115013</b>											
 <p>One Single Left Center, One Double Right Cushions</p>  <p>One Single Right Center, One Double Right Cushions</p>	COM	2075	Grade J	2585	Leather V	3756	54	3	OH	18¼	AH
	COL	2250	Grade K	2622	Edel 1	3606			OW	40	WBA
	Grade AA	2235	Grade L	2655	Edel 2	3786			OD	18	DED
	Grade A	2275	Grade M	2688	Edel 3	4056			SH	18¼	DEW
	Grade B	2315	Grade N	2742	Edel 4	4116			SD	16	R
	Grade C	2355	Grade P	2788	Edel 5	4446			Shipping Weight Cube		
	Grade D	2392	Grade Q	2828	Edel 6	4596					
	Grade E	2425	Leather I	2795	Edel 7	5016					
	Grade F	2468	Leather II	3156	Edel 12	7656					
	Grade G	2502	Leather III	3456							
	Grade H	2552	Leather IV	3636							
	Three Seat Bench   One Single & One Double Seat Cushion   Polished Aluminum Legs								level® Certified SCS Indoor Advantage™ Certified		



# Cheval Series

## Benches & Tables

	List Prices			Sq.Ft.	Yards	Dimensions						
<b>Cheval HHL115013</b>												
 <p>One Double Right Center Cushions</p>  <p>One Double Left Center Cushions</p>	COM	1750	Grade J	2090	Leather V	2871	36	2	OH	18¼	AH	
	COL	1925	Grade K	2114	Edel 1	2771			OW	60	WBA	
	Grade AA	1857	Grade L	2137	Edel 2	2891			OD	18	DED	
	Grade A	1883	Grade M	2159	Edel 3	3071			SH	18¼	DEW	
	Grade B	1910	Grade N	2194	Edel 4	3111			SD	16	R	
	Grade C	1937	Grade P	2226	Edel 5	3331			Shipping Weight			
	Grade D	1961	Grade Q	2252	Edel 6	3431			Cube			
	Grade E	1983	Leather I	2230	Edel 7	3711						
	Grade F	2012	Leather II	2471	Edel 12	5471						
	Grade G	2034	Leather III	2671								
	Grade H	2068	Leather IV	2791								

Three Seat Bench | One Double Seat Cushion | Polished Aluminum Legs

level® Certified  
SCS Indoor Advantage™ Certified

<b>Cheval HHL115013</b>												
	COM	2125	Grade J	2635	Leather V	3806	54	3	OH	18¼	AH	
	COL	2300	Grade K	2672	Edel 1	3656			OW	60	WBA	
	Grade AA	2285	Grade L	2705	Edel 2	3836			OD	18	DED	
	Grade A	2325	Grade M	2738	Edel 3	4106			SH	18¼	DEW	
	Grade B	2365	Grade N	2792	Edel 4	4166			SD	16	R	
	Grade C	2405	Grade P	2838	Edel 5	4496			Shipping Weight			
	Grade D	2442	Grade Q	2878	Edel 6	4646			Cube			
	Grade E	2475	Leather I	2845	Edel 7	5066						
	Grade F	2518	Leather II	3206	Edel 12	7706						
	Grade G	2552	Leather III	3506								
	Grade H	2602	Leather IV	3686								

Three Seat Bench | One Full Seat Cushion | Polished Aluminum Legs

level® Certified  
SCS Indoor Advantage™ Certified



# Cheval Series

## Modulars



---

### Cheval Series Specifications

---

**Collection Details**                      Bench Seating & Tables | Modulars  
20" | 40" | 60" | 45° Corner Unit | 90° Corner Unit

---

**Surfaces**                                      Ash  
Refer to HBF Standard Ash finishes for color selection. Finish selection must be noted on order.

---

**Leg Finish**                                      Polished Aluminum

---

**Cushion**                                        Single 16" | Double 26" | Full (Triple) 56"

---

**Cushion Placement**                      Left Center | Center | Right Center

Cushion Positions	
NC	No Cushion
SC	Single Cushion
DC	Double Cushion
TC	Triple Cushion
NA	Not Applicable



# Cheval Series

## Modulars

### Cheval Series Specifications

#### Leg Placement

End Inset | Connector

Leg Placement	
<b>LFI</b>	Left Facing Inset
<b>LFC</b>	Left Facing Connector
<b>LFN</b>	Left Facing - No Leg
<b>RFI</b>	Right Facing Inset
<b>RFC</b>	Right Facing Connector
<b>RFN</b>	Right Facing - No Leg

#### Modular Corner Units

45° | 90° (22½°, 45°, 22½°)

##### 45° Modular Corner Unit

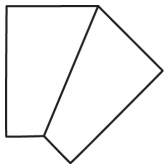

Top View



Corner Unit



Corner Unit with Left Facing Leg

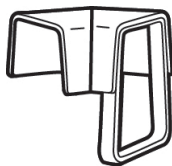

Corner Unit with Right Facing Leg

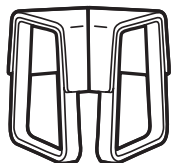

Corner Unit with Two Legs

##### 90° Modular Corner Unit

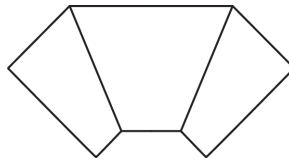

Top View

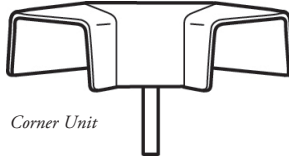

Corner Unit

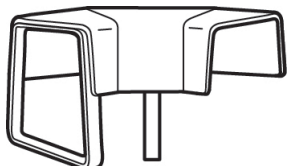

Corner Unit with Left Facing Leg

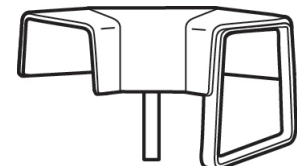

Corner Unit with Right Facing Leg

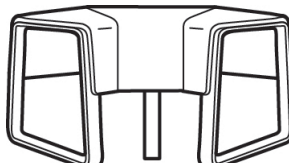

Corner Unit with Two Legs



# Cheval Series

## Modulars

---

### Modular Configuration Options

---

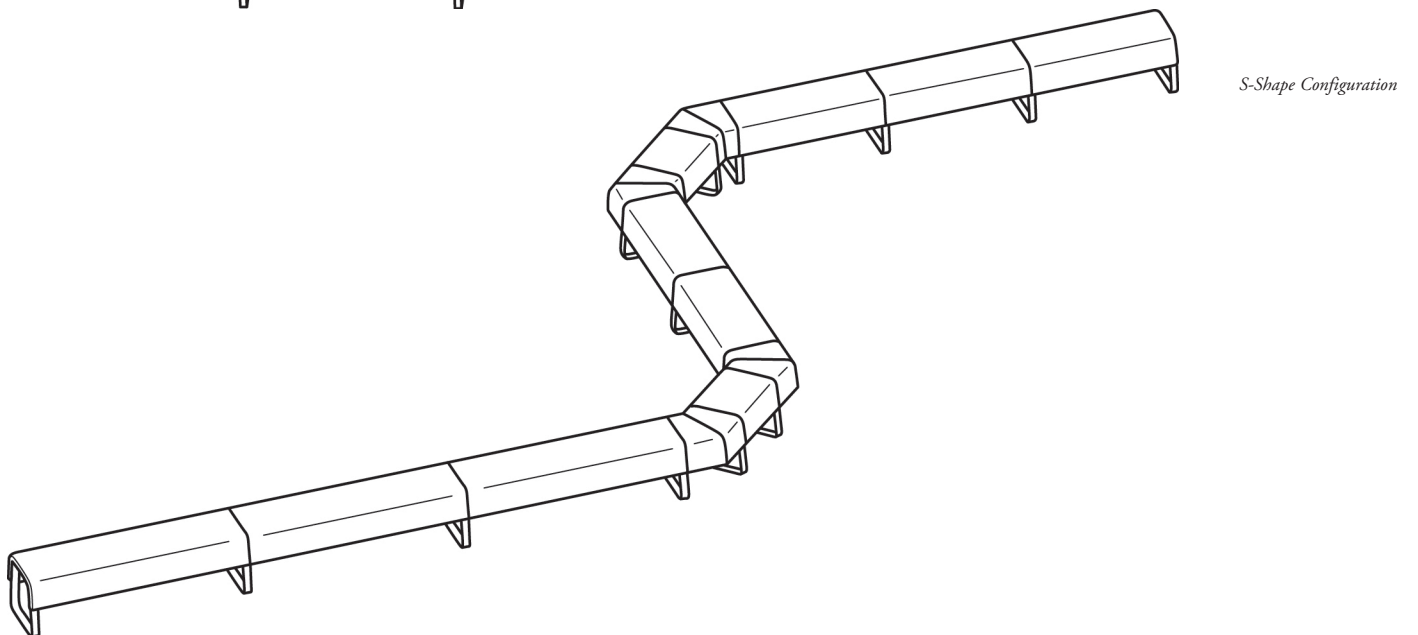
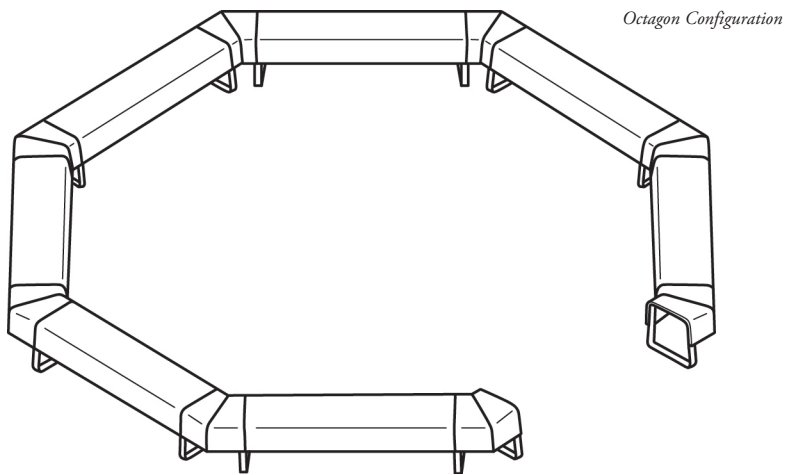
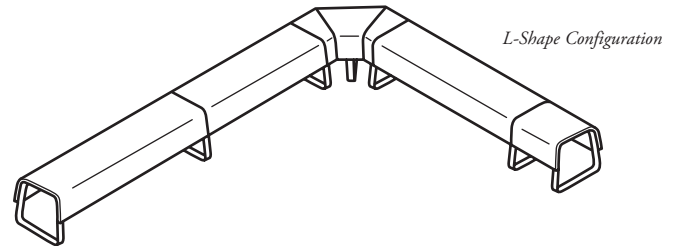
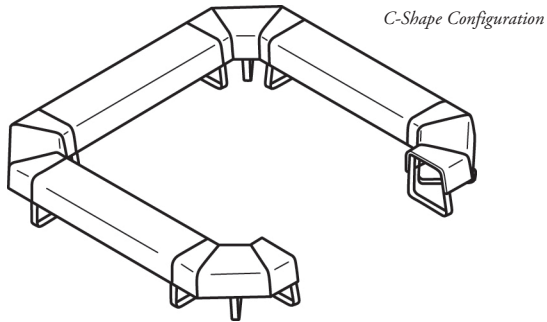





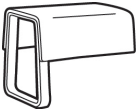
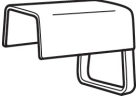
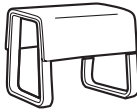

# Cheval Series

## Modulars

	List Prices	Sq.Ft.	Yards	Dimensions	
<b>Cheval HHL115021</b>					
	775			OH 17½ AH OW 20 WBA OD 17 DED SH 17½ DEW SD 15 R	
				Shipping Weight Cube	
				level® Certified SCS Indoor Advantage™ Certified	
<b>Cheval HHL115021</b>					
	925			OH 17½ AH OW 20 WBA OD 17 DED SH 17½ DEW SD 15 R	
<i>Left Facing Leg</i>					
					
<i>Right Facing Leg</i>					
				Shipping Weight Cube	
				level® Certified SCS Indoor Advantage™ Certified	
<b>Cheval HHL115021</b>					
	1075			OH 17½ AH OW 20 WBA OD 17 DED SH 17½ DEW SD 15 R	
				Shipping Weight Cube	
				level® Certified SCS Indoor Advantage™ Certified	
<b>Cheval HHL115021</b>					
	COM 1100 COL 1275 Grade AA 1153 Grade A 1167 Grade B 1180 Grade C 1193 Grade D 1206 Grade E 1217 Grade F 1231 Grade G 1242 Grade H 1259	Grade J 1270 Grade K 1282 Grade L 1293 Grade M 1304 Grade N 1322 Grade P 1338 Grade Q 1351 Leather I 1340 Leather II 1460 Leather III 1560 Leather IV 1620	Leather V 1660 Edel 1 1610 Edel 2 1670 Edel 3 1760 Edel 4 1780 Edel 5 1890 Edel 6 1940 Edel 7 2080 Edel 12 2960	18 1	OH 18¼ AH OW 20 WBA OD 18 DED SH 18¼ DEW SD 16 R
				Shipping Weight Cube	
				level® Certified SCS Indoor Advantage™ Certified	



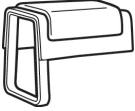
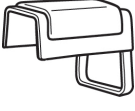

# Cheval Series

## Modulars

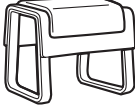
	List Prices				Sq.Ft.	Yards	Dimensions				
<b>Cheval HHL115021</b>											
 <i>Left Facing Leg</i>   <i>Right Facing Leg</i>	COM	1250	Grade J	1420	Leather V	1810	18	1	OH 18¼	AH	
	COL	1425	Grade K	1432	Edel 1	1760			OW 20	WBA	
	Grade AA	1303	Grade L	1443	Edel 2	1820			OD 18	DED	
	Grade A	1317	Grade M	1454	Edel 3	1910			SH 18¼	DEW	
	Grade B	1330	Grade N	1472	Edel 4	1930			SD 16	R	
	Grade C	1343	Grade P	1488	Edel 5	2040					
	Grade D	1356	Grade Q	1501	Edel 6	2090					
	Grade E	1367	Leather I	1490	Edel 7	2230					
	Grade F	1381	Leather II	1610	Edel 12	3110					
	Grade G	1392	Leather III	1710							
	Grade H	1409	Leather IV	1770							
										Shipping Weight	
										Cube	
One Seat Bench   Single Seat Cushion   Polished Aluminum Leg										level® Certified	
										SCS Indoor Advantage™ Certified	

<b>Cheval HHL115021</b>											
 <i>Left Facing Leg</i>	COM	1400	Grade J	1570	Leather V	1960	18	1	OH 18¼	AH	
	COL	1575	Grade K	1582	Edel 1	1910			OW 20	WBA	
	Grade AA	1453	Grade L	1593	Edel 2	1970			OD 18	DED	
	Grade A	1467	Grade M	1604	Edel 3	2060			SH 18¼	DEW	
	Grade B	1480	Grade N	1622	Edel 4	2080			SD 16	R	
	Grade C	1493	Grade P	1638	Edel 5	2190					
	Grade D	1506	Grade Q	1651	Edel 6	2240					
	Grade E	1517	Leather I	1640	Edel 7	2380					
	Grade F	1531	Leather II	1760	Edel 12	3260					
	Grade G	1542	Leather III	1860							
	Grade H	1559	Leather IV	1920							
										Shipping Weight	
										Cube	
One Seat Bench   Single Seat Cushion   Polished Aluminum Legs										level® Certified	
										SCS Indoor Advantage™ Certified	

<b>Cheval HHL115022</b>										
 <i>Two Seat Bench</i>	900								OH 17½	AH
									OW 40	WBA
									OD 17	DED
									SH 17½	DEW
									SD 15	R
Two Seat Bench   No Cushion										Shipping Weight
										Cube
										level® Certified
										SCS Indoor Advantage™ Certified

<b>Cheval HHL115022</b>											
 <i>Left Single Seat Cushion</i>   <i>Right Single Seat Cushion</i>	COM	1225	Grade J	1395	Leather V	1785	18	1	OH 18¼	AH	
	COL	1400	Grade K	1407	Edel 1	1735			OW 40	WBA	
	Grade AA	1278	Grade L	1418	Edel 2	1795			OD 18	DED	
	Grade A	1292	Grade M	1429	Edel 3	1885			SH 18¼	DEW	
	Grade B	1305	Grade N	1447	Edel 4	1905			SD 16	R	
	Grade C	1318	Grade P	1463	Edel 5	2015					
	Grade D	1331	Grade Q	1476	Edel 6	2065					
	Grade E	1342	Leather I	1465	Edel 7	2205					
	Grade F	1356	Leather II	1585	Edel 12	3085					
	Grade G	1367	Leather III	1685							
	Grade H	1384	Leather IV	1745							
										Shipping Weight	
										Cube	
Two Seat Bench   Single Seat Cushion										level® Certified	
										SCS Indoor Advantage™ Certified	





# Cheval Series

## Modulars

	List Prices			Sq.Ft.	Yards	Dimensions			
<b>Cheval HHL115022</b>									
	COM	1550	Grade J	1890	Leather V	2671	36	2	OH 18¼ AH
	COL	1725	Grade K	1914	Edel 1	2571			OW 40 WBA
	Grade AA	1657	Grade L	1937	Edel 2	2691			OD 18 DED
	Grade A	1683	Grade M	1959	Edel 3	2871			SH 18¼ DEW
	Grade B	1710	Grade N	1994	Edel 4	2911			SD 16 R
	Grade C	1737	Grade P	2026	Edel 5	3131			
	Grade D	1761	Grade Q	2052	Edel 6	3231			Shipping Weight
	Grade E	1783	Leather I	2030	Edel 7	3511			Cube
	Grade F	1812	Leather II	2271	Edel 12	5271			
	Grade G	1834	Leather III	2471					
	Grade H	1868	Leather IV	2591					
Two Seat Bench   Two Single Seat Cushions						level® Certified SCS Indoor Advantage™ Certified			

<b>Cheval HHL115022</b>									
	COM	1325	Grade J	1665	Leather V	2446	36	2	OH 18¼ AH
	COL	1500	Grade K	1689	Edel 1	2346			OW 40 WBA
	Grade AA	1432	Grade L	1712	Edel 2	2466			OD 18 DED
	Grade A	1458	Grade M	1734	Edel 3	2646			SH 18¼ DEW
	Grade B	1485	Grade N	1769	Edel 4	2686			SD 16 R
	Grade C	1512	Grade P	1801	Edel 5	2906			
	Grade D	1536	Grade Q	1827	Edel 6	3006			Shipping Weight
	Grade E	1558	Leather I	1805	Edel 7	3286			Cube
	Grade F	1587	Leather II	2046	Edel 12	5046			
	Grade G	1609	Leather III	2246					
	Grade H	1643	Leather IV	2366					
Two Seat Bench   Single Full Cushion   Polished Aluminum Legs						level® Certified SCS Indoor Advantage™ Certified			

<b>Cheval HHL115022</b>									
 <p>Left Facing Leg</p>  <p>Right Facing Leg</p>	1050			36	2	OH 17½ AH			
						OW 40 WBA			
						OD 17 DED			
						SH 17½ DEW			
						SD 15 R			
Two Seat Bench   No Cushion   Polished Aluminum Legs						Shipping Weight Cube			
						level® Certified SCS Indoor Advantage™ Certified			



# Cheval Series

## Modulars

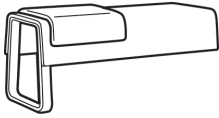
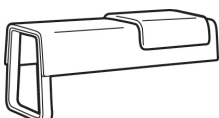
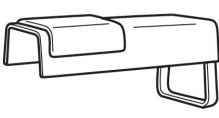
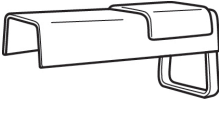

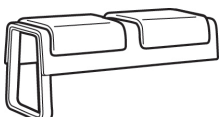
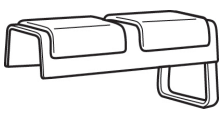
	List Prices			Sq.Ft.	Yards	Dimensions					
<b>Cheval HHL115022</b>											
 <i>Left Facing Leg   Left Single Seat Cushion</i>	COM	1675	Grade J	1545	36	2	OH	18¼	AH		
	COL	1550	Grade K	1557			Edel 1	1885	OW	40	WBA
	Grade AA	1428	Grade L	1568			Edel 2	1945	OD	18	DED
	Grade A	1442	Grade M	1579			Edel 3	2035	SH	18¼	DEW
	Grade B	1455	Grade N	1597			Edel 4	2055	SD	16	R
	Grade C	1468	Grade P	1613			Edel 5	2165	Shipping Weight Cube		
	Grade D	1481	Grade Q	1626			Edel 6	2215			
	Grade E	1492	Leather I	1615			Edel 7	2355			
	Grade F	1506	Leather II	1735			Edel 12	3235			
	Grade G	1517	Leather III	1835							
	Grade H	1534	Leather IV	1895							
 <i>Left Facing Leg   Right Single Seat Cushion</i>											
	 <i>Right Facing Leg   Left Single Seat Cushion</i>										
		 <i>Right Facing Leg   Right Single Seat Cushion</i>									
			Two Seat Bench   One Single Seat Cushion   Polished Aluminum Legs						level® Certified SCS Indoor Advantage™ Certified		

<b>Cheval HHL115022</b>											
 <i>Left Facing Leg</i>	COM	1700	Grade J	2040	36	2	OH	18¼	AH		
	COL	1875	Grade K	2064			Edel 1	2721	OW	40	WBA
	Grade AA	1807	Grade L	2087			Edel 2	2841	OD	18	DED
	Grade A	1833	Grade M	2109			Edel 3	3021	SH	18¼	DEW
	Grade B	1860	Grade N	2144			Edel 4	3061	SD	16	R
	Grade C	1887	Grade P	2176			Edel 5	3281	Shipping Weight Cube		
	Grade D	1911	Grade Q	2202			Edel 6	3381			
	Grade E	1933	Leather I	2176			Edel 7	3661			
	Grade F	1962	Leather II	2421			Edel 12	5421			
	Grade G	1984	Leather III	2621							
	Grade H	2018	Leather IV	2741							
 <i>Right Facing Leg</i>											
	Two Seat Bench   Two Single Seat Cushions   Polished Aluminum Legs						level® Certified SCS Indoor Advantage™ Certified				

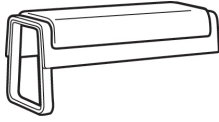

# Cheval Series

## Modulars

	List Prices				Sq.Ft.	Yards	Dimensions				
<b>Cheval HHL115022</b>											
	COM	1475	Grade J	1815	Leather V	2596	36	2	OH	18¼	AH
	COL	1650	Grade K	1839	Edel 1	2496			OW	40	WBA
	Grade AA	1582	Grade L	1862	Edel 2	2616	OD	18	DED		
	Grade A	1608	Grade M	1884	Edel 3	2796	SH	18¼	DEW		
	Grade B	1635	Grade N	1919	Edel 4	2836	SD	16	R		
	Grade C	1662	Grade P	1951	Edel 5	3056	Shipping Weight				
	Grade D	1686	Grade Q	1977	Edel 6	3156	Cube				
	Grade E	1708	Leather I	1955	Edel 7	3436					
	Grade F	1737	Leather II	2196	Edel 12	5196					
	Grade G	1759	Leather III	2396							
	Grade H	1793	Leather IV	2516							

Two Seat Bench | Single Full Cushion | Polished Aluminum Legs

level® Certified  
SCS Indoor Advantage™ Certified

<b>Cheval HHL115022</b>									
	1200						OH	17½	AH
							OW	40	WBA
						OD	17	DED	
						SH	17½	DEW	
						SD	15	R	
						Shipping Weight			
						Cube			
						level® Certified			
						SCS Indoor Advantage™ Certified			
Two Seat Bench   No Cushion   Polished Aluminum Legs									

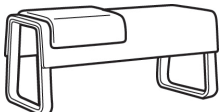
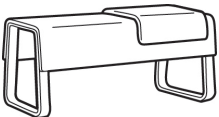
<b>Cheval HHL115022</b>											
	COM	1525	Grade J	1695	Leather V	2085	18	1	OH	18¼	AH
	COL	1700	Grade K	1707	Edel 1	2035			OW	40	WBA
	Grade AA	1578	Grade L	1718	Edel 2	2095	OD	18	DED		
	Grade A	1592	Grade M	1729	Edel 3	2185	SH	18¼	DEW		
	Grade B	1605	Grade N	1747	Edel 4	2205	SD	16	R		
	Grade C	1618	Grade P	1763	Edel 5	2315	Shipping Weight				
	Grade D	1631	Grade Q	1776	Edel 6	2365	Cube				
	Grade E	1642	Leather I	1765	Edel 7	2505					
	Grade F	1656	Leather II	1885	Edel 12	3385					
	Grade G	1667	Leather III	1985							
	Grade H	1684	Leather IV	2045							

Two Seat Bench | One Single Cushion | Polished Aluminum Legs

level® Certified  
SCS Indoor Advantage™ Certified



# Cheval Series

## Modulars

	List Prices			Sq.Ft.	Yards	Dimensions			
<b>Cheval HHL115022</b>									
	COM	<b>1850</b>	Grade J	<b>2190</b>	Leather V	<b>2971</b>	36	2	OH 18¼ AH
	COL	<b>2025</b>	Grade K	<b>2214</b>	Edel 1	<b>2871</b>			OW 40 WBA
	Grade AA	<b>1957</b>	Grade L	<b>2237</b>	Edel 2	<b>2991</b>			OD 18 DED
	Grade A	<b>1983</b>	Grade M	<b>2259</b>	Edel 3	<b>3171</b>			SH 18¼ DEW
	Grade B	<b>2010</b>	Grade N	<b>2294</b>	Edel 4	<b>3211</b>			SD 16 R
	Grade C	<b>2037</b>	Grade P	<b>2326</b>	Edel 5	<b>3431</b>			
	Grade D	<b>2061</b>	Grade Q	<b>2352</b>	Edel 6	<b>3531</b>			Shipping Weight
	Grade E	<b>2083</b>	Leather I	<b>2330</b>	Edel 7	<b>3811</b>			Cube
	Grade F	<b>2112</b>	Leather II	<b>2571</b>	Edel 12	<b>5571</b>			
	Grade G	<b>2134</b>	Leather III	<b>2771</b>					
	Grade H	<b>2168</b>	Leather IV	<b>2891</b>					
Two Seat Bench   Two Single Seat Cushions   Polished Aluminum Legs						level® Certified SCS Indoor Advantage™ Certified			



<b>Cheval HHL115022</b>									
	COM	<b>1625</b>	Grade J	<b>1965</b>	Leather V	<b>2746</b>	36	2	OH 18¼ AH
	COL	<b>1800</b>	Grade K	<b>1989</b>	Edel 1	<b>2646</b>			OW 40 WBA
	Grade AA	<b>1732</b>	Grade L	<b>2012</b>	Edel 2	<b>2766</b>			OD 18 DED
	Grade A	<b>1758</b>	Grade M	<b>2034</b>	Edel 3	<b>2946</b>			SH 18¼ DEW
	Grade B	<b>1785</b>	Grade N	<b>2069</b>	Edel 4	<b>2986</b>			SD 16 R
	Grade C	<b>1812</b>	Grade P	<b>2101</b>	Edel 5	<b>3206</b>			
	Grade D	<b>1836</b>	Grade Q	<b>2127</b>	Edel 6	<b>3306</b>			Shipping Weight
	Grade E	<b>1858</b>	Leather I	<b>2105</b>	Edel 7	<b>3586</b>			Cube
	Grade F	<b>1887</b>	Leather II	<b>2346</b>	Edel 12	<b>5346</b>			
	Grade G	<b>1909</b>	Leather III	<b>2546</b>					
	Grade H	<b>1943</b>	Leather IV	<b>2666</b>					
Two Seat Bench   One Single Full Seat Cushion   Polished Aluminum Legs						level® Certified SCS Indoor Advantage™ Certified			



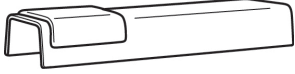

# Cheval Series

## Modulars

	List Prices	Sq.Ft.	Yards	Dimensions
<b>Cheval HHL115023</b>				
	1025			OH 17½ AH OW 60 WBA OD 17 DED SH 17½ DEW SD 15 R
				Shipping Weight Cube
Three Seat Bench   No Cushion				level® Certified SCS Indoor Advantage™ Certified

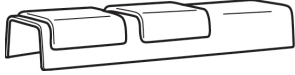
	List Prices	Sq.Ft.	Yards	Dimensions
<b>Cheval HHL115023</b>				
	COM 1350 COL 1525 Grade AA 1403 Grade A 1417 Grade B 1430 Grade C 1443 Grade D 1456 Grade E 1467 Grade F 1481 Grade G 1492 Grade H 1509	Grade J 1520 Grade K 1532 Grade L 1543 Grade M 1554 Grade N 1572 Grade P 1588 Grade Q 1601 Leather I 1590 Leather II 1710 Leather III 1810 Leather IV 1870	Leather V 1910 Edel 1 1860 Edel 2 1920 Edel 3 2010 Edel 4 2030 Edel 5 2140 Edel 6 2190 Edel 7 2330 Edel 12 3210	18 1 OH 18¼ AH OW 60 WBA OD 18 DED SH 18¼ DEW SD 16 R
				
				
Three Seat Bench   One Single Seat Cushion				Shipping Weight Cube level® Certified SCS Indoor Advantage™ Certified

	List Prices	Sq.Ft.	Yards	Dimensions
<b>Cheval HHL115023</b>				
	COM 1675 COL 1850 Grade AA 1782 Grade A 1808 Grade B 1835 Grade C 1862 Grade D 1886 Grade E 1908 Grade F 1937 Grade G 1959 Grade H 1993	Grade J 2015 Grade K 2039 Grade L 2062 Grade M 2084 Grade N 2119 Grade P 2151 Grade Q 2177 Leather I 2155 Leather II 2396 Leather III 2596 Leather IV 2716	Leather V 2796 Edel 1 2696 Edel 2 2816 Edel 3 2996 Edel 4 3036 Edel 5 3256 Edel 6 3356 Edel 7 3636 Edel 12 5396	36 2 OH 18¼ AH OW 60 WBA OD 18 DED SH 18¼ DEW SD 16 R
				
				
Three Seat Bench   Two Single Cushion   Polished Aluminum Legs				Shipping Weight Cube level® Certified SCS Indoor Advantage™ Certified



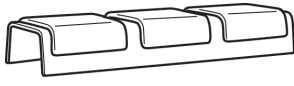

# Cheval Series

## Modulars

	List Prices			Sq.Ft.	Yards	Dimensions				
<b>Cheval HHL115023</b>										
	COM	<b>2000</b>	Grade J	<b>2510</b>	Leather V	<b>3681</b>	54	3	OH 18¼	AH
	COL	<b>2175</b>	Grade K	<b>2547</b>	Edel 1	<b>3531</b>			OW 60	WBA
	Grade AA	<b>2160</b>	Grade L	<b>2580</b>	Edel 2	<b>3711</b>			OD 18	DED
	Grade A	<b>2200</b>	Grade M	<b>2613</b>	Edel 3	<b>3981</b>			SH 18¼	DEW
	Grade B	<b>2240</b>	Grade N	<b>2667</b>	Edel 4	<b>4041</b>			SD 16	R
	Grade C	<b>2280</b>	Grade P	<b>2713</b>	Edel 5	<b>4371</b>				
	Grade D	<b>2317</b>	Grade Q	<b>2753</b>	Edel 6	<b>4521</b>				
	Grade E	<b>2350</b>	Leather I	<b>2720</b>	Edel 7	<b>4941</b>				
	Grade F	<b>2393</b>	Leather II	<b>3081</b>	Edel 12	<b>7581</b>				
	Grade G	<b>2427</b>	Leather III	<b>3381</b>						
	Grade H	<b>2477</b>	Leather IV	<b>3561</b>						
Shipping Weight Cube										
level® Certified SCS Indoor Advantage™ Certified										
Three Seat Bench   Three Single Cushions   Polished Aluminum Legs										

<b>Cheval HHL115023</b>										
	COM	<b>1825</b>	Grade J	<b>2335</b>	Leather V	<b>3506</b>	54	3	OH 18¼	AH
	COL	<b>2000</b>	Grade K	<b>2372</b>	Edel 1	<b>3356</b>			OW 60	WBA
	Grade AA	<b>1985</b>	Grade L	<b>2405</b>	Edel 2	<b>3536</b>			OD 18	DED
	Grade A	<b>2025</b>	Grade M	<b>2438</b>	Edel 3	<b>3806</b>			SH 18¼	DEW
	Grade B	<b>2065</b>	Grade N	<b>2492</b>	Edel 4	<b>3866</b>			SD 16	R
	Grade C	<b>2105</b>	Grade P	<b>2538</b>	Edel 5	<b>4196</b>				
	Grade D	<b>2142</b>	Grade Q	<b>2578</b>	Edel 6	<b>4346</b>				
	Grade E	<b>2175</b>	Leather I	<b>2545</b>	Edel 7	<b>4766</b>				
	Grade F	<b>2218</b>	Leather II	<b>2906</b>	Edel 12	<b>7406</b>				
	Grade G	<b>2252</b>	Leather III	<b>3206</b>						
	Grade H	<b>2302</b>	Leather IV	<b>3386</b>						
Shipping Weight Cube										
level® Certified SCS Indoor Advantage™ Certified										
Three Seat Bench   One Full Seat Cushion										

<b>Cheval HHL115023</b>										
	<b>1175</b>								OH 17½	AH
									OW 60	WBA
Shipping Weight Cube										
level® Certified SCS Indoor Advantage™ Certified										
Three Seat Bench   No Cushion										
										
Shipping Weight Cube										
level® Certified SCS Indoor Advantage™ Certified										





# Cheval Series

## Modulars

List Prices				Sq.Ft.	Yards	Dimensions				
<b>Cheval HHL115023</b>										
COM	1500	Grade J	1670	Leather V	2060	18	1	OH	18¼	AH
COL	1675	Grade K	1682	Edel 1	2010			OW	60	WBA
Grade AA	1553	Grade L	1693	Edel 2	2070			OD	18	DED
Grade A	1567	Grade M	1704	Edel 3	2160			SH	18¼	DEW
Grade B	1580	Grade N	1722	Edel 4	2180			SD	16	R
Grade C	1593	Grade P	1738	Edel 5	2290					
Grade D	1606	Grade Q	1751	Edel 6	2340					
Grade E	1617	Leather I	1740	Edel 7	2480					
Grade F	1631	Leather II	1860	Edel 12	3360					
Grade G	1642	Leather III	1960							
Grade H	1659	Leather IV	2020							

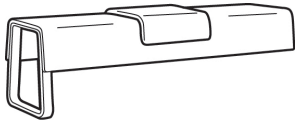

One Single Center Seat Cushion | Left Facing Leg

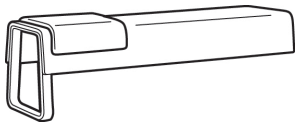

One Single Left Center Seat Cushion | Left Facing Leg



One Single Right Center Seat Cushion | Left Facing Leg

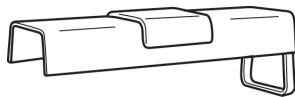

One Single Center Seat Cushion | Right Facing Leg

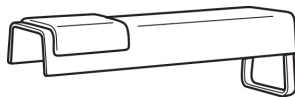

One Single Left Center Seat Cushion | Right Facing Leg

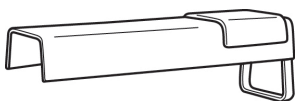

One Single Right Center Seat Cushion | Right Facing Leg

Three Seat Bench | One Single Seat Cushion

level® Certified  
SCS Indoor Advantage™ Certified



# Cheval Series

## Modulars

List Prices				Sq.Ft.	Yards	Dimensions				
<b>Cheval HHL115023</b>										
COM	1825	Grade J	2165	Leather V	2946	36	2	OH	18¼	AH
COL	2000	Grade K	2189	Edel 1	2846			OW	60	WBA
Grade AA	1932	Grade L	2212	Edel 2	2966			OD	18	DED
Grade A	1958	Grade M	2234	Edel 3	3146			SH	18¼	DEW
Grade B	1985	Grade N	2269	Edel 4	3186			SD	16	R
Grade C	2012	Grade P	2301	Edel 5	3406			Shipping Weight		
Grade D	2036	Grade Q	2327	Edel 6	3506			Cube		
Grade E	2058	Leather I	2305	Edel 7	3786					
Grade F	2087	Leather II	2546	Edel 12	5546					
Grade G	2109	Leather III	2746							
Grade H	2143	Leather IV	2866							

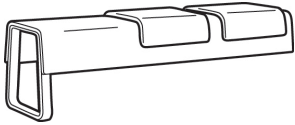

Two Single Right Center Seat Cushions | Left Facing Leg

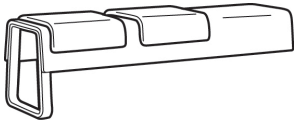

Two Single Left Center Seat Cushions | Left Facing Leg

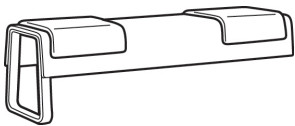

Two Single Split Center Seat Cushions | Left Facing Leg

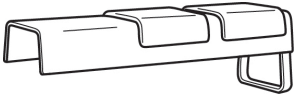

Two Single Right Center Seat Cushions | Right Facing Leg

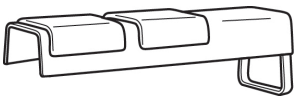

Two Single Left Center Seat Cushions | Right Facing Leg

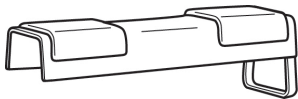

Two Single Split Center Seat Cushions | Right Facing Leg

Three Seat Bench | Two Single Seat Cushions

level® Certified  
SCS Indoor Advantage™ Certified



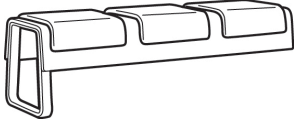
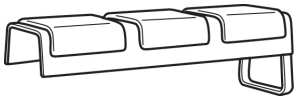

# Cheval Series

## Modulars

	List Prices				Sq.Ft.	Yards	Dimensions			
<b>Cheval HHL115023</b>										
 <i>Left Facing Leg</i>   <i>Right Facing Leg</i>	COM	2150	Grade J	2660	Leather V	3831	54	3	OH 18¼	AH
	COL	2325	Grade K	2697	Edel 1	3681			OW 60	WBA
	Grade AA	2310	Grade L	2730	Edel 2	3861			OD 18	DED
	Grade A	2350	Grade M	2763	Edel 3	4131			SH 18¼	DEW
	Grade B	2390	Grade N	2817	Edel 4	4191			SD 16	R
	Grade C	2430	Grade P	2863	Edel 5	4521			Shipping Weight	
	Grade D	2467	Grade Q	2903	Edel 6	4671			Cube	
	Grade E	2500	Leather I	2870	Edel 7	5091				
	Grade F	2543	Leather II	3231	Edel 12	7731				
	Grade G	2577	Leather III	3531						
	Grade H	2627	Leather IV	3711						

Three Seat Bench | Three Single Seat Cushions

level® Certified  
SCS Indoor Advantage™ Certified

<b>Cheval HHL115023</b>										
 <i>Left Facing Leg</i>   <i>Right Facing Leg</i>	COM	1975	Grade J	2485	Leather V	3656	54	3	OH 18¼	AH
	COL	2150	Grade K	2522	Edel 1	3506			OW 60	WBA
	Grade AA	2135	Grade L	2555	Edel 2	3686			OD 18	DED
	Grade A	2175	Grade M	2588	Edel 3	3956			SH 18¼	DEW
	Grade B	2215	Grade N	2642	Edel 4	4016			SD 16	R
	Grade C	2255	Grade P	2688	Edel 5	4346			Shipping Weight	
	Grade D	2292	Grade Q	2728	Edel 6	4496			Cube	
	Grade E	2325	Leather I	2695	Edel 7	4916				
	Grade F	2368	Leather II	3056	Edel 12	7556				
	Grade G	2402	Leather III	3356						
	Grade H	2452	Leather IV	3536						

Three Seat Bench | One Full Seat Cushions

level® Certified  
SCS Indoor Advantage™ Certified

<b>Cheval HHL115023</b>										
 <i>Left Facing Leg</i>	COM	1325							OH 17½	AH
	COL								OW 60	WBA
	Grade AA								OD 17	DED
	Grade A								SH 17½	DEW
	Grade B								SD 15	R
	Grade C								Shipping Weight	
									Cube	

Three Seat Bench | No Seat Cushion | Polished Aluminum Legs

level® Certified  
SCS Indoor Advantage™ Certified



# Cheval Series

## Modulars

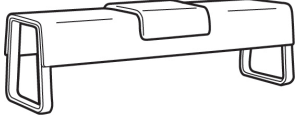
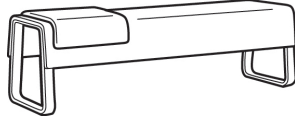
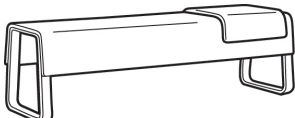
	List Prices			Sq.Ft.	Yards	Dimensions				
<b>Cheval HHL115023</b>										
 <i>One Single Center Seat Cushion</i>	COM	1650	Grade J	1820	Leather V	2210	18	1	OH 18¼	AH
	COL	1825	Grade K	1832	Edel 1	2160			OW 60	WBA
	Grade AA	1703	Grade L	1843	Edel 2	2220			OD 18	DED
	Grade A	1717	Grade M	1854	Edel 3	2310			SH 18¼	DEW
	Grade B	1730	Grade N	1872	Edel 4	2330			SD 16	R
	Grade C	1743	Grade P	1888	Edel 5	2440				
	Grade D	1756	Grade Q	1901	Edel 6	2490				
	Grade E	1767	Leather I	1890	Edel 7	2630				
	Grade F	1781	Leather II	2010	Edel 12	3510				
	Grade G	1792	Leather III	2110						
	Grade H	1809	Leather IV	2170						
 <i>One Single Left Center Seat Cushion</i>										
 <i>One Single Right Center Seat Cushion</i>										
										Shipping Weight Cube

Three Seat Bench | One Single Seat Cushion | Polished Aluminum Legs

level® Certified  
SCS Indoor Advantage™ Certified

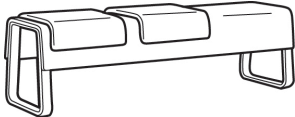
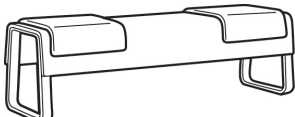
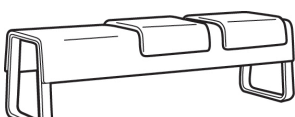
	List Prices			Sq.Ft.	Yards	Dimensions				
<b>Cheval HHL115023</b>										
 <i>Two Single Left Center Seat Cushions</i>	COM	1975	Grade J	2315	Leather V	3096	36	2	OH 18¼	AH
	COL	2150	Grade K	2339	Edel 1	2996			OW 60	WBA
	Grade AA	2082	Grade L	2362	Edel 2	3116			OD 18	DED
	Grade A	2108	Grade M	2384	Edel 3	3296			SH 18¼	DEW
	Grade B	2135	Grade N	2419	Edel 4	3336			SD 16	R
	Grade C	2162	Grade P	2451	Edel 5	3556				
	Grade D	2186	Grade Q	2477	Edel 6	3656				
	Grade E	2208	Leather I	2455	Edel 7	3936				
	Grade F	2237	Leather II	2696	Edel 12	5696				
	Grade G	2259	Leather III	2896						
	Grade H	2293	Leather IV	3016						
 <i>Two Single Split Center Seat Cushions</i>										
 <i>Two Single Right Center Seat Cushions</i>										
										Shipping Weight Cube

Three Seat Bench | Two Single Seat Cushions | Polished Aluminum Legs

level® Certified  
SCS Indoor Advantage™ Certified



# Cheval Series

## Modulars

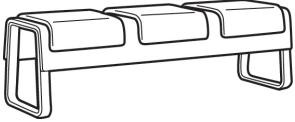
	List Prices				Sq.Ft.	Yards	Dimensions			
<b>Cheval HHL115023</b>										
	COM	2300	Grade J	2810	Leather V	3981	54	3	OH 18¼	AH
	COL	2475	Grade K	2847	Edel 1	3831			OW 60	WBA
	Grade AA	2460	Grade L	2880	Edel 2	4011			OD 18	DED
	Grade A	2500	Grade M	2913	Edel 3	4281			SH 18¼	DEW
	Grade B	2540	Grade N	2967	Edel 4	4341			SD 16	R
	Grade C	2580	Grade P	3013	Edel 5	4671				
	Grade D	2617	Grade Q	3053	Edel 6	4821				
	Grade E	2650	Leather I	3020	Edel 7	5241				
	Grade F	2693	Leather II	3381	Edel 12	7881				
	Grade G	2727	Leather III	3681						
	Grade H	2777	Leather IV	3861						
										Shipping Weight
									Cube	

Three Seat Bench | Three Single Seat Cushions | Polished Aluminum Legs

level® Certified  
SCS Indoor Advantage™ Certified

	List Prices				Sq.Ft.	Yards	Dimensions			
<b>Cheval HHL115023</b>										
	COM	2125	Grade J	2635	Leather V	3806	54	3	OH 18¼	AH
	COL	2300	Grade K	2672	Edel 1	3656			OW 60	WBA
	Grade AA	2285	Grade L	2705	Edel 2	3836			OD 18	DED
	Grade A	2325	Grade M	2738	Edel 3	4106			SH 18¼	DEW
	Grade B	2365	Grade N	2792	Edel 4	4166			SD 16	R
	Grade C	2405	Grade P	2838	Edel 5	4496				
	Grade D	2442	Grade Q	2878	Edel 6	4646				
	Grade E	2475	Leather I	2845	Edel 7	5066				
	Grade F	2518	Leather II	3206	Edel 12	7706				
	Grade G	2552	Leather III	3506						
	Grade H	2602	Leather IV	3686						
										Shipping Weight
									Cube	



Three Seat Bench | One Full Seat Cushion | Polished Aluminum Legs

level® Certified  
SCS Indoor Advantage™ Certified

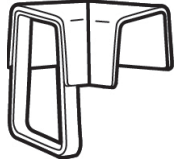

# Cheval Series

## Modulars

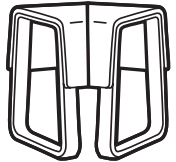
	List Prices	Sq.Ft.	Yards	Dimensions
<b>Cheval HHL115029</b>				
	1075	36	2	OH 17½ AH OW 20 WBA OD 18¾ DED SH 17½ DEW SD 15 R  Shipping Weight Cube  <div style="text-align: right;">level® Certified SCS Indoor Advantage™ Certified</div>
<b>Cheval HHL115029</b>				
	1225	36	2	OH 17½ AH OW 20 WBA OD 18¾ DED SH 17½ DEW SD 15 R  Shipping Weight Cube
<i>Left Facing Leg</i>				
				
<i>Right Facing Leg</i>				
45° Corner Unit Modular   One Polished Aluminum Leg				<div style="text-align: right;">level® Certified SCS Indoor Advantage™ Certified</div>
<b>Cheval HHL115029</b>				
	1375	36	2	OH 17½ AH OW 20 WBA OD 18¾ DED SH 17½ DEW SD 15 R  Shipping Weight Cube  <div style="text-align: right;">level® Certified SCS Indoor Advantage™ Certified</div>
45° Corner Unit Modular   Two Polished Aluminum Legs				







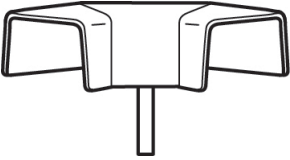
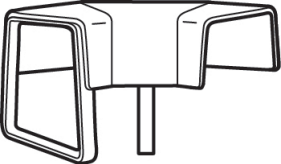
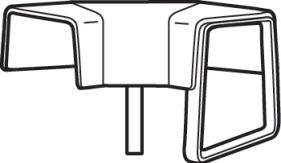
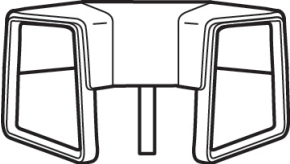





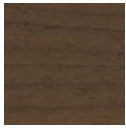
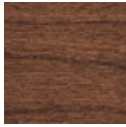
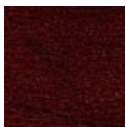

# Cheval Series

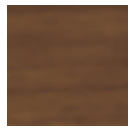
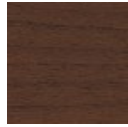
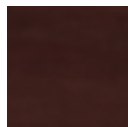
## Modulars

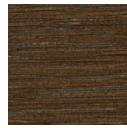
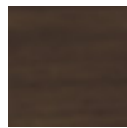
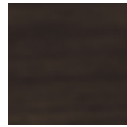
	List Prices	Sq.Ft.	Yards	Dimensions
<b>Cheval HHL115039</b>				
	1650	36	2	OH 17½ AH OW 20 WBA OD 18¾ DED SH 17½ DEW SD 15 R  Shipping Weight Cube
90° Corner Unit Modular				level <sup>®</sup> Certified SCS Indoor Advantage™ Certified
<b>Cheval HHL115039</b>				
	1800	36	2	OH 17½ AH OW 20 WBA OD 18¾ DED SH 17½ DEW SD 15 R  Shipping Weight Cube
<i>Left Facing Leg</i>  				
<i>Right Facing Leg</i>  90° Corner Unit Modular   One Polished Aluminum Leg				level <sup>®</sup> Certified SCS Indoor Advantage™ Certified
<b>Cheval HHL115039</b>				
	1950	36	2	OH 17½ AH OW 20 WBA OD 18¾ DED SH 17½ DEW SD 15 R  Shipping Weight Cube
90° Corner Unit Modular   Two Polished Aluminum Legs				level <sup>®</sup> Certified SCS Indoor Advantage™ Certified

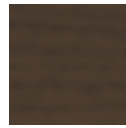
**SEATING MATERIAL OPTIONS**



**MAPLE: (NE)**

	NE800 Natural Maple		NE706 Wheat Cherry		NE777 Burnished Cherry		NE744 Canyon Cherry		NE511 Dark Red Cherry
	NE873 Honey Maple		NE701 Light Cherry		NE601 Light Roast Walnut		NE215 Medium Brown Cherry		NE615 Coffee Walnut
	NE629 Nutmeg Walnut		NE290 Mocha		NE693 Sumatra Walnut		NE684 Dark Roast Walnut		NE284 Chicory Cherry
	NE667 Charcoal Grey Walnut		NE293 Chestnut Cherry		NE531 Dark Rift Oak		EB300 Ebony (Charlote)		RF331 Dark Rift Oak

**OAK: (RF)**

	RF310 Smoke (Panone 407U)		RF637 Charcoal Grey Walnut		RF301 Light Rift Oak		RF230 Mocha		RF331 Dark Rift Oak
---	------------------------------	---	-------------------------------	---	-------------------------	---	----------------	---	------------------------

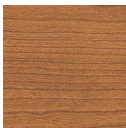
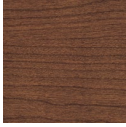
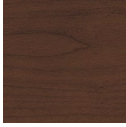
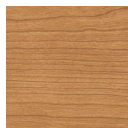
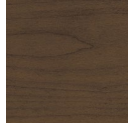
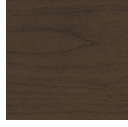
**CHERRY: (NC)**

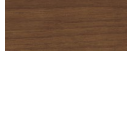
	NC701 Light Cherry		NC744 Canyon Cherry		NC511 Dark Red Cherry
	NC706 Wheat Cherry		NC777 Burnished Cherry		NC293 Chestnut Cherry
			NC215 Med. Brown Cherry		NC284 Chicory Cherry

**WALNUT: (NT)**

	NT629 Nutmeg Walnut		NT615 Coffee Walnut		NT637 Charcoal Grey Walnut
	NT601 Light Roast Walnut		NT693 Sumatra Walnut		NT509 Ebony Walnut
			NT684 Dark Roast Walnut		

**INLAYS:**

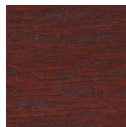
	ANI Anigre (Esplanade)		SAL S. American Lacewood (Esplanade)		BPW Black Pearwood (Esplanade)
---	------------------------------	--	---	---	--------------------------------------

Screen images are intended as a guide only and should not be regarded as absolutely correct. For exact color/texture, please contact the HBF Resource Center at [resourcecenter@hbf.com](mailto:resourcecenter@hbf.com) for an actual sample.



**SEATING MATERIAL OPTIONS**

<b>ASH: (AH)</b>		<b>PAINTED WOOD FINISHES:</b>	
	AH400 Clear Ash		SP Satin Pewter
	AH800 Natural Maple		MU Muslin (C Collection)
	AH706 Wheat Cherry		MS Mirror (C Collection)
	AH777 Burnished Cherry		LG Light Grey
	AH744 Canyon Cherry		WPSW Designer White (Soft White) (Nest)
	AH601 Light Roast Walnut		
	AH701 Light Cherry		
	AH629 Nutmeg Walnut		
	AH673 Honey Maple		
	AH230 Mocha		
	AH684 Dark Roast Walnut		
	AH693 Sumatra Walnut		
	AH511 Dark Red Cherry		
	AH284 Chioory Cherry		
	AH403 Grey Opaque		
	AH402 Black Opaque		
	AH401 White Opaque		
	AH301 Light Rift Oak		
	PC Polished Chrome		BS Brushed Stainless
	AH310 Smoke (Panone 407U)		PA Polished Aluminum
	AH331 Dark Rift Oak		PS Polished Stainless
	BC Brushed Copper		BB Brushed Brass
	BA Brushed Aluminum		FCO Polished Copper

Screen images are intended as a guide only and should not be regarded as absolutely correct. For exact color/texture, please contact the HBF Resource Center at resourcecenter@hbf.com for an actual sample.